

- 1. Корпус.
- 2. Крышка.
- 3. Блок знакоместа.
- 4. Блок десятичной точки.
- 5. Блок контроллера.
- 6. Винт замка.
- 7. Скоба крепления.
- 8. Разъем.
- 9. Упор.

Рис. 1

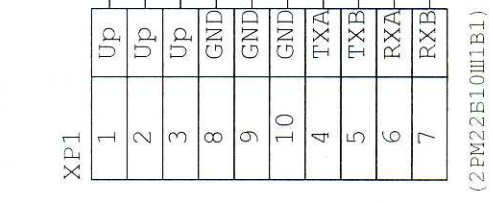

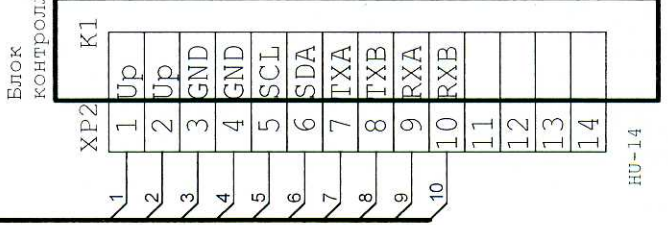
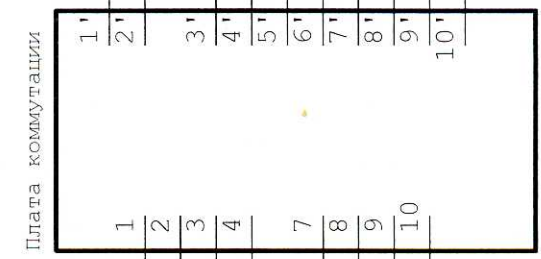
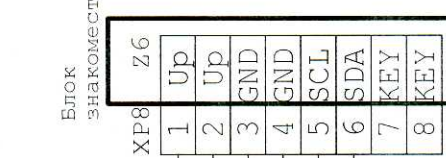
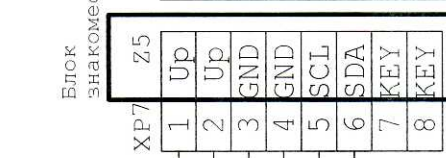
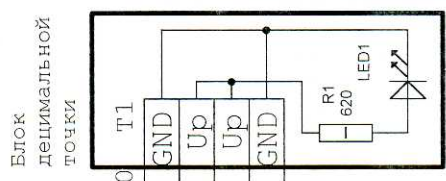
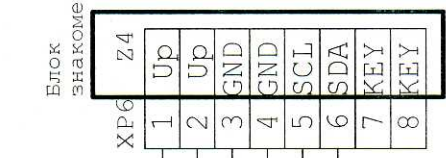
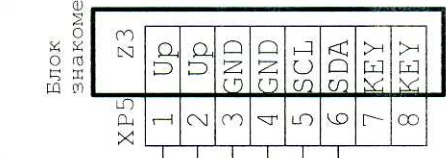
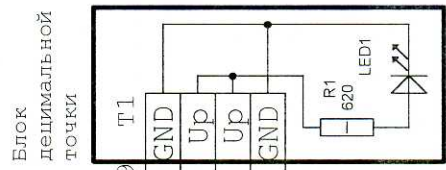
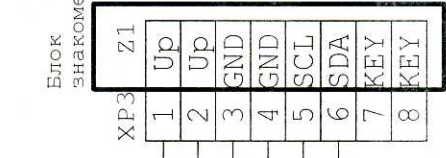

Рис. 3





Рис. 5

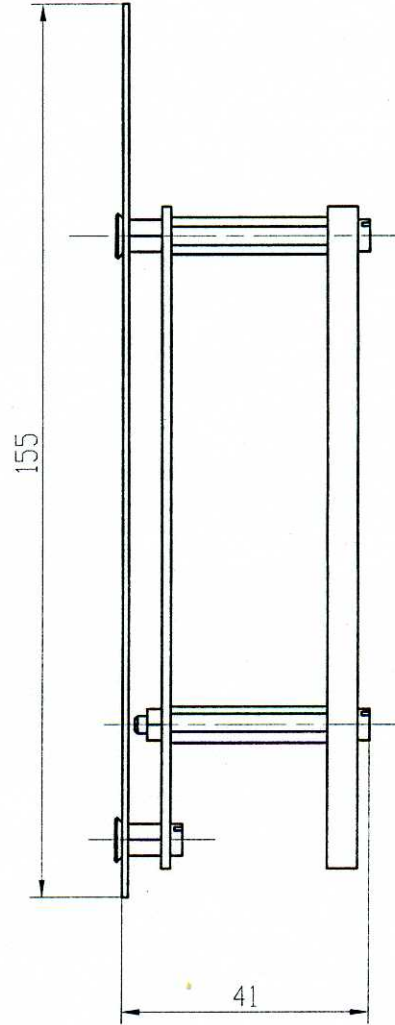
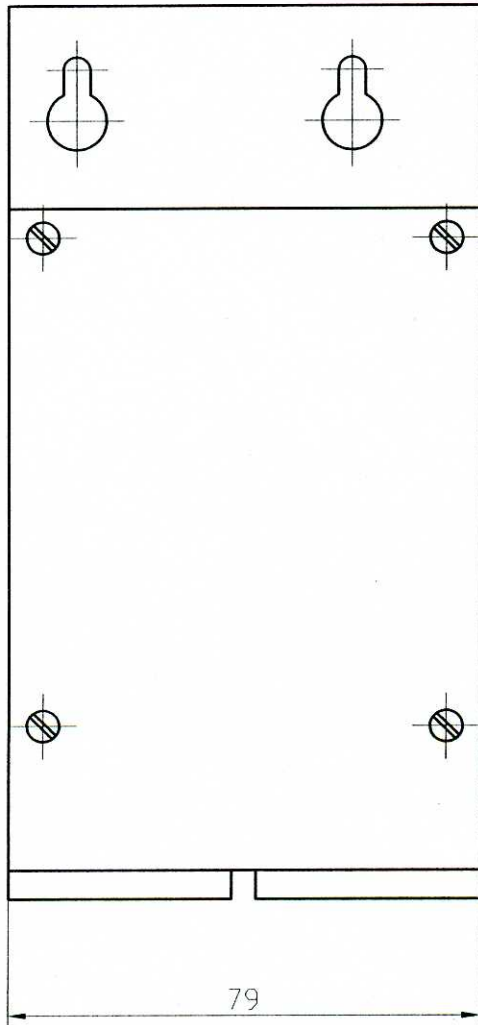

Рис. 7

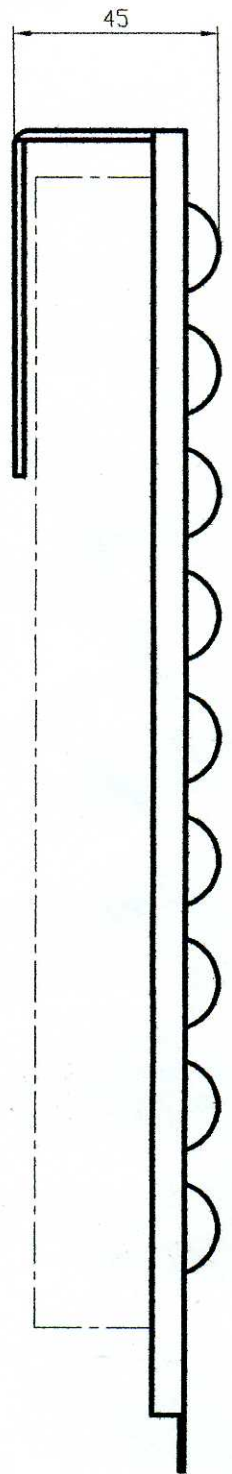
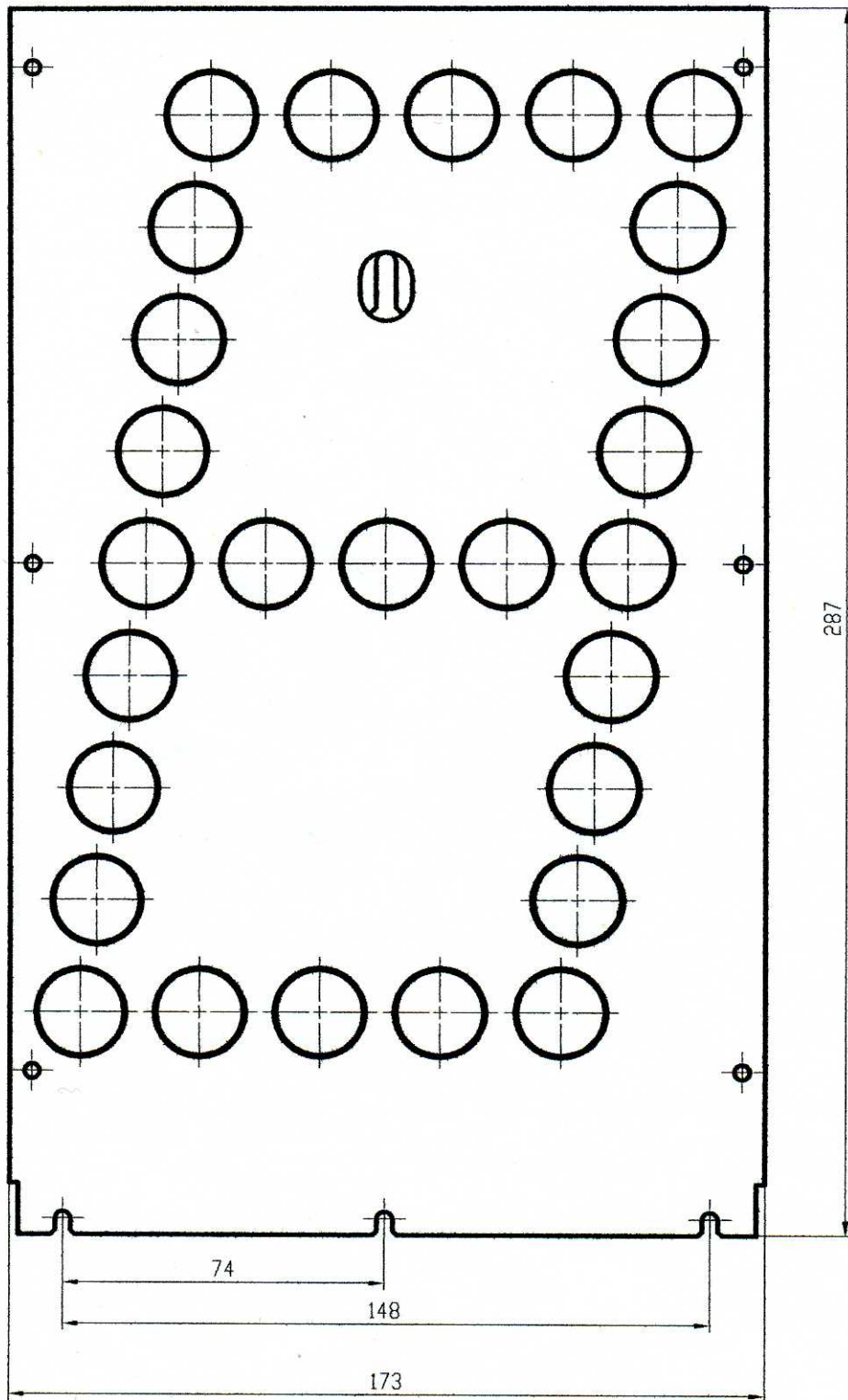
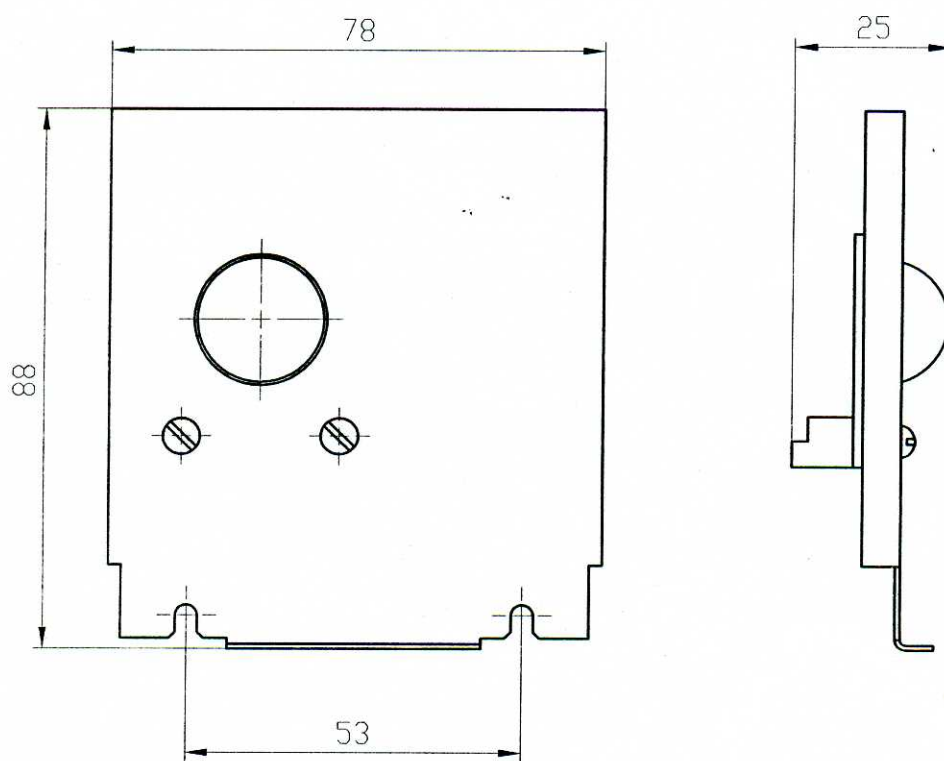